

CONFERENCE

DECCA | CONTRACT

Decca Conference is a line of extraordinary conferencing furniture set apart by design, quality and the beauty of craft, providing a place to gather and converse, collaborate and connect. A Decca table is the tangible presence of character, integrity and excellence, realized in a n array of forms and a spohisticated palette of materials to offer exceptional creative choices.

Offering complete custom capabilities, the Conference "Made To Order" program allows the product to be tailored to your exact specifications. Express a unique design statement realized through premium materialsd, quality finishing and uncompromising attention to detail--all Decca hallmarks. We welcome custom requests. Look for the MTO symbol throughout this price list.

GENERAL PRODUCT SPECIFICATIONS

VENEERS

All exposed surfaces are offered in hand selected veneers. All veneer surfaces are book-matched resulting in superior wood grain aesthetics.

WORK SURFACES

Desks have profiled edges front and back and flush side panels. All worksurface height tops also have chemically impregnated polycell backer for additional worksurface durability.

FINISH

A multi-step modified polyurethane finish is applied to all finished cases.

STANDARD FINISHES:

#104	CHAMPAGNE CHERRY	#501	EV ROSEWOOD
#105	LIGHT CHERRY	#502	EV EBONY
#107	AMERICAN CHERRY	#503	EV WALNUT
#119	BEECH	#505	EV BLACK APRICOT
#121	COFFEE	#506	EV OAK
#125	FLAT CUT NON-FIG WALNUT	#510	EV CLEAR OAK
#133	SAND OAK	#512	EV NATURAL RATTAN
#134	FOREST OAK	#514	EV FLAT CUT OAK
#136	DARK OAK		
#137	SORREL WALNUT		
#139	SABLE WALNUT		
#147	QUARTER CUT FIGURED ASH		
#148	QUARTER CUT CERUSED OAK		
#149	EBONIZED ASH		
#150	FIGURED WALNUT		
#151	CLEAR FIGURED WALNUT		
#153	KNOTTY OAK		
#154	SMOKE GRAY ASH		
#155	GRAY OAK		
#156	ESPRESSO ASH		
#157	BLUE ASH		
#158	WHITE ASH		
#159	EUCALYPTUS		
#164	NATURAL WALNUT		

FOR PREMIUM VENEER, PLEASE CONTACT CUSTOMER SERVICE.

ANIGRE	SYCAMORE
MAHOGNAY	AVODIRE
PRIME VERA FIGURED	ZEBRAWOOD
EBONY	THUYA BURL

Other Species Available

GENERAL PRODUCT SPECIFICATIONS

FOR LACQUER FINISH, PLEASE CONTACT CUSTOMER SERVICE.

STANDARD LACQUER FINISHES:

- 005 PURE WHITE
- 006 SOFT WHITE
- 009 PEARL WHITE
- 010 WARM WHITE
- 012 ELLSWORTH GREEN
- 013 ELLSWORTH ORANGE
- 014 ELLSWORTH RED
- 015 ELLSWORTH BLUE
- 016 ELLSWORTH GRAY
- 018 BRITE WHITE
- 019 MISSION WHITE
- 020 BRIGHT WHITE
- 021 MATTE BLACK
- 025 GRAY BLUE
- 026 ULTRA WHITE

PREMIUM LACQUER FINISHES:

- 007 TAUPE
- 008 WARM DARK GRAY
- 011 GLOSSY PURE WHITE
- 017 KINKOU RED
- 022 GLOSSY DARK PURPLE
- 023 CHAMPAGNE
- 024 BRONZE

STANDARD METAL FINISHES:

POWDER COAT METAL FINISHES:

- #304 SILVER
- #305 BLACK
- #306 DARK BRONZE
- #310 WHITE
- #311 WARM DARK GRAY

PREMIUM METAL GRADE I FINISHES:

- #301 POLISHED STAINLESS STEEL
- #302 SATIN STAINLESS STEEL

PREMIUM METAL GRADE II FINISHES:

- #308 SATIN DARK BRONZE
- #314 POLISHED BRASS
- #315 BLACKEND STEEL
- #316 MIRROR BLACK MATTE
- #317 MIRROR BLACK POLISHED
- #318 CHAMPAGNE STEEL
- #319 BRUSHED AMBER
- #320 BRUSHED BRASS

GLASS OPTIONS:

- | | |
|-------------------------------|---|
| #401 WHITE BACK PAINTED GLASS | #408 CLEAR LOW IRON GLASS |
| #402 BLACK BACK PAINTED GLASS | #409 BRONZE FROSTED MIRROR GLASS |
| #403 FROSTED MIRROR GLASS | #410 GRAY FROSTED MIRROR GLASS |
| #406 FROSTED GLASS | #411 BLACK FROSTED MIRROR GLASS |
| #407 BLACK MIRROR GLASS | #412 ARCHITECTURAL WHITE BACK PAINTED GLASS |

SOLID SURFACE OPTIONS:

- | | |
|----------------|----------------|
| #404 SSF WHITE | #405 SSF BLACK |
|----------------|----------------|

STONE OPTIONS

- | | |
|-----------|---------------|
| CARERRA | NERO MARQUINA |
| EMPERADOR | INDIA GREEN |

FOR CUSTOMER OWN STONE, PLEASE CONTACT CUSTOMER SERVICE.

VENEER

Dialogue Conference tables are available in a wide variety of shapes and sizes. All tables in this collection are based on a standard height of 30". If there are special needs Dialogue is versatile enough to be Made To Order for special requests. Please contact your local Sales Representative or Customer Service.

All furniture comes standard with flat cut book-match veneer; flat cut slip-match veneer can also be specified. Quarter cut slip-match and quarter cut book-match veneers are available at a 5% upcharge. Other veneer layups are listed on page 6.

STANDARD VENEER LAYUPS

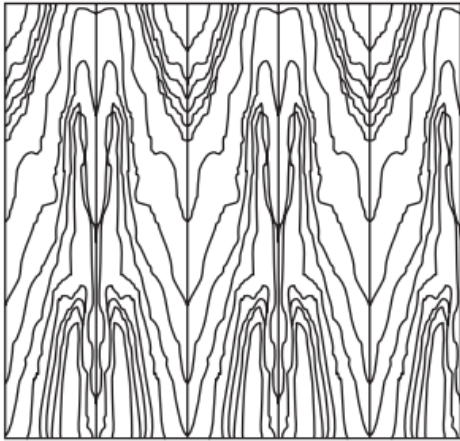

Flat Cut Book Match

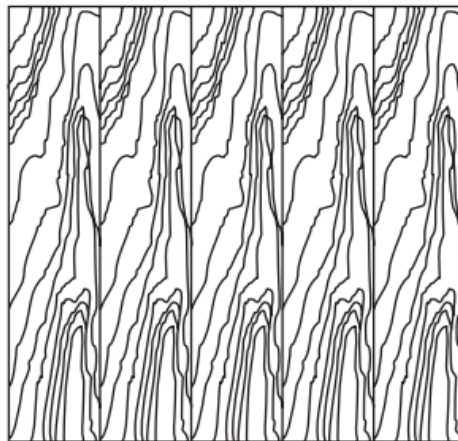

Flat Cut Slip Match

STANDARD VENEER GRAIN DIRECTION



CONFERENCE TABLE TOP

Standard grain runs parallel to width on conference table tops.

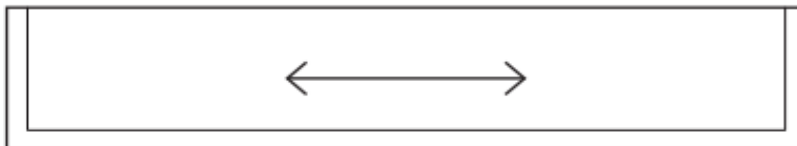

CREDENZA

3 side edge profiles on buffet are standard.

Standard grain runs parallel to length on credenza top.

4 side edge profiles are by request only. Option upcharge 10%.

SPECIALTY VENEER LAYUP OPTIONS ON TOPS: MTO

In addition to our expansive portfolio of standard and exotic veneers, Decca also offers finely crafted veneer patterns. These handcrafted patterns add a level of aesthetic detail that will give a unique signature to any project. Inspired designs are enhanced by the use of Decca veneer artwork.

Contact Customer Service for more information.

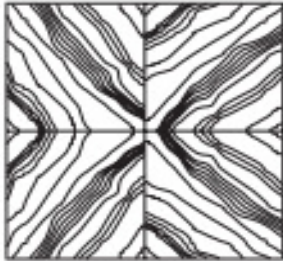

RD Reverse Diamond

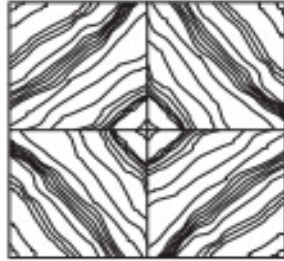

DA Diamond Top 02

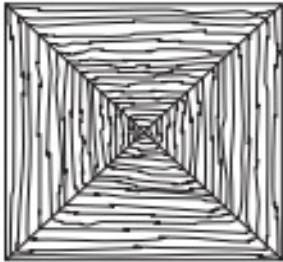

BX Box Top

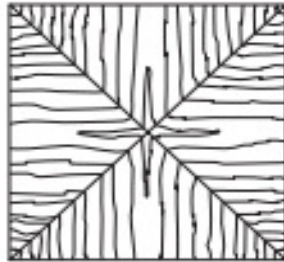

RB Reverse Box



SB Sunburst Top



CK Checker Top



HG Herringbone Top

EDGES AND VENEER BORDERS

Standard Edge

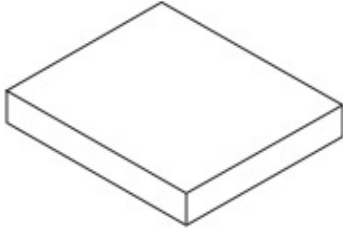

Standard Edge

Solid wood edge. See page 106 for thickness information.

Inlay and Border Options

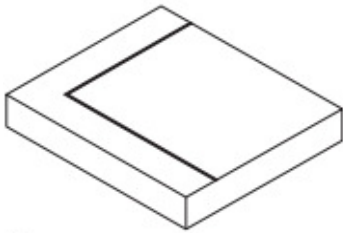

Inlay

Inlays are .25 inches thick, and are placed 4 inches inboard from the table edge.

Inlay is fabricated from solid aluminum stock, finished to specification in one of three standard colors and are set flush to the table top surface.

Inlay Finishes

- A** Satin Silver Inlay
- B** Satin Black Inlay
- S** Satin Bronze Inlay

For contrasting wood inlay please contact Customer Service

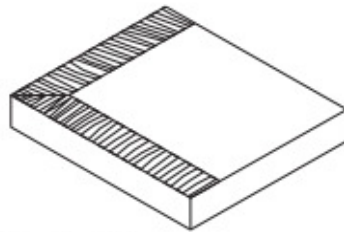

Quartered Border

No Inlay

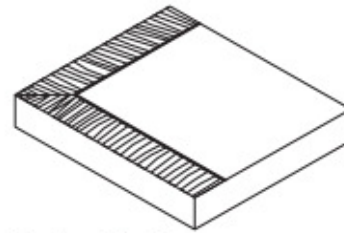

Quartered Border

Wood or Metal Inlay

EDGES

Edgebands are shaped from solid hardwood.

GRADE ONE EDGES

Index Edges Overall thickness: 1.5"

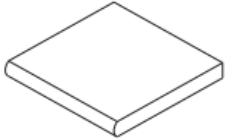

Edge 18

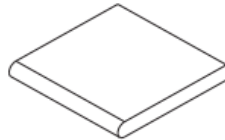

Edge 19

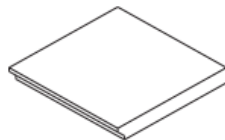

Edge 20

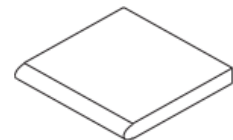

Edge 21

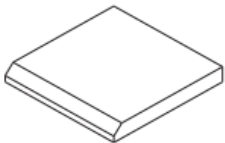

Edge 22

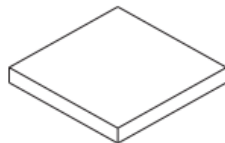

Edge 23

GRADE TWO EDGES

Basis Edges Overall thickness: 2.25"

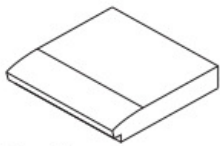

Edge 15

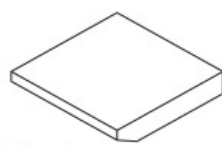

Edge 16

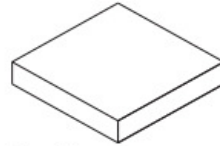

Edge 1A

Dialogue Edges Overall thickness: 1.5"

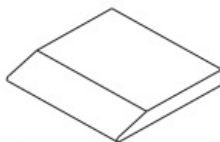

Edge 11

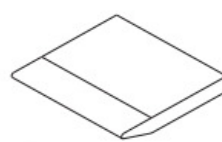

Edge 24

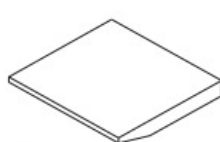

Edge 25

Palladia Edges Overall thickness: 1.5"
with 2" quarter cut standard veneer border

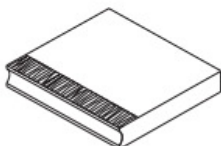

Palladia Moderne Edge 12

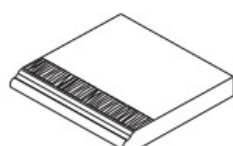

Palladia Classic Edge 8

Turnberry Edges Overall thickness: 1.5"
with 2" quarter cut standard veneer border

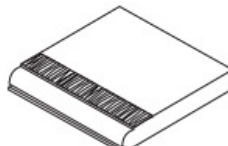

Turnberry Edge 4

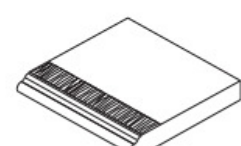

Turnberry Edge 8

PULLS AND KNOBS

Standard in Silver Powder Coat finish. Surcharge may apply when premium pull finish is selected.

Basis Pulls

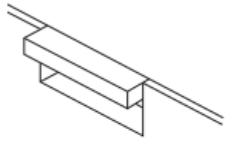

- 1A** Brushed Stainless Steel finish
- 2A** Brushed Bronze finish
- 3A** Satin Black finish

Dialogue Pulls

No pulls - touch latch is standard.

Index Pulls



DX BP



DX CP



DX KP



DX AP

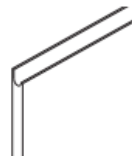

DX WP Wood Finger Groove

Palladia Pulls



PD 2A



PD 2B



PD 2C



PD 3A



PD 3B



PD 4A



PD 4B

Turnberry Pulls



TB 1A



TB 1B



TB 2A



TB 2B

Conference Table Tops

DESCRIPTION	MODEL	Specifications			
		WIDTH	DEPTH	SEAT	SECTION
Square Tops	DG SQ3636	36	36	4	1
	DG SQ4242	42	42	4	1
	DG SQ4848	48	48	4	1
	DG SQ5454	54	54	8	1
	DG SQ6060	60	60	8	1
	DG SQ6666	66	66	8	1
	DG SQ7272	72	72	8	1
	DG SQ7878	78	78	12	1

NOTES

FINISHES

For a complete list of finishes please go to www.deccacontract.com

Dimensions are in inches and are approximate.
Contact Customer Service if dimensions are critical.

* Indicates model illustrated by line drawing.

Conference Table Tops

DESCRIPTION	MODEL	Specifications			
		WIDTH	DEPTH	SEAT	SECTION
Rectangular Tops	DG RE4836	48	36	4	1
	DG RE6030	60	30	6	1
	DG RE6036	60	36	6	1
	DG RE7236	72	36	6	1
	DG RE7836	78	36	6	1
	DG RE7842	78	42	6	1
	DG RE8442	84	42	8	1
	DG RE9642	96	42	8	1
	DG RE9648	96	48	10	1
	DG RE10242	102	42	10	1
	DG RE10248	102	48	10	1
	DG RE10842	108	42	10	1
	DG RE10848	108	48	10	1
	DG RE10854	108	54	10	1
	DG RE11448	114	48	10	1
	DG RE11454	114	54	10	1
	DG RE12048	120	48	10	1
	DG RE12054	120	54	10	1
	DG RE12060	120	60	10	1

NOTES



FINISHES

For a complete list of finishes please go to www.deccacontract.com

Dimensions are in inches and are approximate.
Contact Customer Service if dimensions are critical.

* Indicates model illustrated by line drawing.

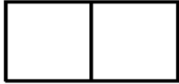

Conference Table Tops

DESCRIPTION	MODEL	Specifications			
		WIDTH	DEPTH	SEAT	SECTION
Rectangular Tops	DG RE14454	144	54	12	2
	DG RE14460	144	60	12	2
	DG RE15654	156	54	12	2
	DG RE15660	156	60	12	2
	DG RE16854	168	54	14	2
	DG RE16860	168	60	14	2
	DG RE18054	180	54	14	2
	DG RE18060	180	60	14	2
	DG RE19254	192	54	14	2
	DG RE19260	192	60	14	2
	DG RE20454	204	54	14	2
	DG RE20460	204	60	14	2
	DG RE21654	216	54	16	3
	DG RE21660	216	60	16	3
	DG RE22854	228	54	16	3
	DG RE22860	228	60	16	3
	DG RE24060	240	60	18	3
	DG RE26460	264	60	20	3
	DG RE28860	288	60	24	3
NOTES					
FINISHES					
For a complete list of finishes please go to www.deccacontract.com					Dimensions are in inches and are approximate. Contact Customer Service if dimensions are critical.
					* Indicates model illustrated by line drawing.

Conference Table Tops

DESCRIPTION	MODEL	Specifications			
		WIDTH	DEPTH	SEAT	SECTION
<p>Racetrack Shaped Tops</p> 	DG CA7236	72	36	6	1
	DG CA7836	78	36	6	1
	DG CA7842	78	42	6	1
	DG CA8442	84	42	8	1
	DG CA9642	96	42	8	1
	DG CA9648	96	48	10	1
	DG CA10242	102	42	10	1
	DG CA10248	102	48	10	1
	DG CA10842	108	42	10	1
	DG CA10848	108	48	10	1
	DG CA10854	108	54	10	1
	DG CA11442	114	42	10	1
	DG CA11448	114	48	10	1
	DG CA11454	114	54	10	1
	DG CA12048	120	48	10	1
DG CA12054	120	54	10	1	
NOTES					
<p>FINISHES</p> <p>For a complete list of finishes please go to www.deccacontract.com</p>	<p>Dimensions are in inches and are approximate. Contact Customer Service if dimensions are critical.</p> <p>* Indicates model illustrated by line drawing.</p>				

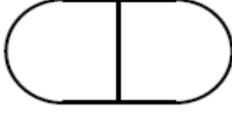
Conference Table Tops

DESCRIPTION	MODEL	Specifications			
		WIDTH	DEPTH	SEAT	SECTION
<p>Racetrack Shaped Tops</p> 	DG CA13248	132	48	10	2
	DG CA13254	132	54	10	2
	DG CA13260	132	60	10	2
	DG CA14454	144	54	12	2
	DG CA14460	144	60	12	2
	DG CA15654	156	54	12	2
	DG CA15660	156	60	12	2
	DG CA16854	168	54	12	2
	DG CA16860	168	60	12	2
	DG CA18054	180	54	12	2
	DG CA18060	180	60	12	2
	DG CA19254	192	54	14	2
	DG CA19260	192	60	14	2
	DG CA20454	204	54	14	2
DG CA20460	204	60	14	2	
	DG CA21654	216	54	16	3
	DG CA21660	216	60	16	3
	DG CA22860	228	60	16	3
	DG CA24060	240	60	18	3
	DG CA26460	264	60	20	3
	DG CA28860	288	60	24	3

NOTES

FINISHES

For a complete list of finishes please go to www.deccacontract.com

Dimensions are in inches and are approximate.
Contact Customer Service if dimensions are critical.

* Indicates model illustrated by line drawing.

Conference Table Tops

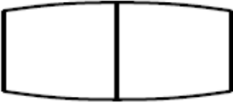
DESCRIPTION	MODEL	Specifications			
		WIDTH	DEPTH	SEAT	SECTION
Boat Shaped Tops 	DG BA7242	72	42/32	6	1
	DG BA7842	78	48/42	6	1
	DG BA8448	84	48/36	8	1
	DG BA9648	96	48/36	8	1
	DG BA10248	102	48/36	8	1
	DG BA10848	102	48/36	8	1
	DG BA10854	108	54/42	8	1
	DG BA11448	114	48/36	8	1
	DG BA11454	114	54/42	8	1
	DG BA12048	120	48/36	10	1
	DG BA12054	120	54/42	10	1
Boat Shaped Tops 	DG BA13254	132	54/42	8	2
	DG BA14454	144	54/42	12	2
	DG BA14460	144	60/48	12	2
	DG BA15654	156	54/42	12	2
	DG BA15660	156	60/48	12	2
	DG BA16854	168	54/42	14	2
	DG BA16860	168	60/48	14	2
	DG BA18054	180	54/42	12	2
	DG BA18060	180	60/48	12	2
	DG BA19254	192	54/42	14	2
	DG BA19260	192	60/48	14	2
	DG BA20454	204	54/42	14	2
	DG BA20460	204	60/48	14	2

NOTES

FINISHES
 For a complete list of finishes
 please go to www.deccacontract.com



Dimensions are in inches and are approximate.
 Contact Customer Service if dimensions are critical.

* Indicates model illustrated by line drawing.

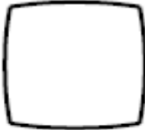
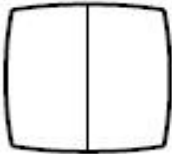
Conference Table Tops

DESCRIPTION	MODEL	Specifications			
		WIDTH	DEPTH	SEAT	SECTION
Boat Shaped Tops	DG BA21660	216	60/48	16	3
	DG BA22860	228	60/48	16	3
	DG BA24060	240	60/48	18	3
	DG BA26460	264	60/48	20	3
	DG BA28860	288	60/48	24	3
	Bowed Square Tops	DG BQ3636	36	36	4
	DG BQ4242	42	42	4	1
	DG BQ4848	48	48	4	1
	DG BQ5454	54	54	8	1
	DG BQ6060	60	60	8	1
	DG BQ6666	66	66	8	1
	DG BQ7272	72	72	8	1
	DG BQ7878	78	78	12	1
	DG BQ8484	84	84	12	1
	DG BQ9090	90	90	12	1
	DG BQ9696	96	96	12	1
Bowed Square Tops	DG BQ102102	102	102	12	2
	DG BQ108108	108	108	16	2
NOTES					
FINISHES	Dimensions are in inches and are approximate. Contact Customer Service if dimensions are critical.				
For a complete list of finishes please go to www.deccacontract.com	* Indicates model illustrated by line drawing.				

Conference Table Tops

DESCRIPTION	MODEL	Specifications			
		WIDTH	DEPTH	SEAT	SECTION
Bowed Rectangular Tops 	DG BR6036	60	36	6	1
	DG BR7236	72	36	6	1
	DG BR8442	84	42	6	1
	DG BR9642	96	42	8	1
	DG BR9648	96	48	8	1
	DG BR10242	102	42	10	1
	DG BR10248	102	48	10	1
	DG BR10842	108	42	10	1
	DG BR10848	108	48	10	1
	DG BR10854	108	54	10	1
	DG BR11442	114	42	10	1
	DG BR11448	114	48	10	1
	DG BR11454	114	54	10	1
	DG BR12048	120	48	10	1
DG BR12054	120	54	10	1	
Bowed Rectangular Tops 	DG BR13248	132	48	10	2
	DG BR13254	132	54	10	2
	DG BR13260	132	60	10	2
	DG BR14454	144	54	12	2
	DG BR14460	144	60	12	2
	DG BR15654	156	54	12	2
	DG BR15660	156	60	14	2
	DG BR16854	168	54	14	2



NOTES

FINISHES
 For a complete list of finishes
 please go to www.deccacontract.com

Dimensions are in inches and are approximate.
 Contact Customer Service if dimensions are critical.

* Indicates model illustrated by line drawing.

Conference Table Tops

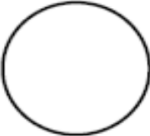
DESCRIPTION	MODEL	Specifications			
		WIDTH	DEPTH	SEAT	SECTION
<p>Bowed Rectangular Tops</p> 	DG BR16860	168	60	12	2
	DG BR18054	180	54	12	2
	DG BR18060	180	60	14	2
	DG BR19254	192	54	14	2
	DG BR19260	192	60	14	2
	DG BR20454	204	54	14	2
	DG BR20460	204	60	14	2
<p>Bowed Rectangular Tops</p> 	DG BR21654	216	54	16	3
	DG BR21660	216	60	16	3
	DG BR24060	240	60	18	3
	DG BR26460	264	60	20	3
	DG BR28860	288	60	24	3
<p>Round Tops</p> 	DG RD36	36	36	2	1
	DG RD42	42	42	3	1
	DG RD48	48	48	4	1
	DG RD54	54	54	4	1
	DG RD60	60	60	5	1
	DG RD66	66	66	5	1
	DG RD72	72	72	6	1
	DG RD78	78	78	6	1

NOTES

FINISHES

For a complete list of finishes please go to www.deccacontract.com

Dimensions are in inches and are approximate.
Contact Customer Service if dimensions are critical.

* Indicates model illustrated by line drawing.

Conference Table Tops

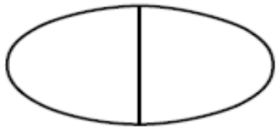
DESCRIPTION	MODEL	Specifications			
		WIDTH	DEPTH	SEAT	SECTION
Oval Tops 	DG OV7236	72	36	4	1
	DG OV7248	72	48	4	1
	DG OV7842	78	42	4	1
	DG OV7848	78	48	4	1
	DG OV8442	84	42	6	1
	DG OV8448	84	48	6	1
	DG OV9648	96	48	8	1
	DG OV9654	96	54	8	1
	DG OV9660	96	60	8	1
	DG OV10848	108	48	8	1
	DG OV10854	108	54	8	1
	DG OV10860	108	60	8	1
	DG OV12048	120	48	8	1
	DG OV12054	120	54	8	1
DG OV12060	120	60	10	1	
Oval Tops 	DG OV13248	132	48	8	2
	DG OV13254	132	54	8	2
	DG OV13260	132	60	10	2
	DG OV14448	144	48	10	2
	DG OV14454	144	54	10	2
	DG OV14460	144	60	10	2

NOTES

FINISHES

For a complete list of finishes please go to www.deccacontract.com

Dimensions are in inches and are approximate.
Contact Customer Service if dimensions are critical.

* Indicates model illustrated by line drawing.

Cable Management

DESCRIPTION	MODEL
-------------	-------

Metal Cable Tray

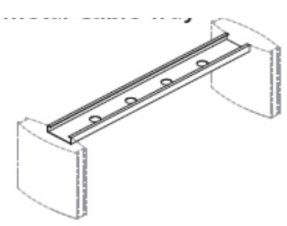

- DG CT72**
- DG CT144**
- DG CT240**

- Formed metal raceway conveys cables horizontally along underside of table top
- Raceway spans between specified bases. Raceway does not provide structural support
- Access holes occur along bottom to facilitate routing of cables
- Standard in painted black finish

NOTES

<p>FINISHES</p> <p>For a complete list of finishes please go to www.deccacontract.com</p>	<p>Dimensions are in inches and are approximate. Contact Customer Service if dimensions are critical.</p> <p>* Indicates model illustrated by line drawing.</p>
---	---

Dialogue Conference Table Tops

Accent Panel with Metal Frame Surround

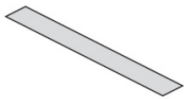

DESCRIPTION	MODEL	
Inlay: Frosted Mirror .25 thick frosted mirror with etched satin surface finish	DG 72XMAP	inlay in 1 section
	DG 144XMAP	inlay in 2 sections
	DG 240XMAP	inlay in 3 sections
Inlay: Black Mirror .25 thick black mirror with etched satin surface finish	DG 72BMAP	inlay in 1 section
	DG 144BMAP	inlay in 2 sections
	DG 240BMAP	inlay in 3 sections
Inlay: Black Glass .25 thick black glass with polished surface finish	DG 72TPAP	inlay in 1 section
	DG 144TPAP	inlay in 2 sections
	DG 240TPAP	inlay in 3 sections
Inlay: White SSF .25 thick white acrylic with honed surface finish	DG 72SSFWAP	inlay in 1 section
	DG 144SSFWAP	inlay in 2 sections
	DG 240SSFWAP	inlay in 3 sections
Inlay: Premium Veneer	DG 72VWAP	inlay in 1 section
	DG 144VWAP	inlay in 2 sections
	DG 240VWAP	inlay in 3 sections

Inlay: Premium Veneer Please contact Customer Service for premium veneer pricing

NOTES

FINISHES

For a complete list of finishes please go to www.deccacontract.com

Dimensions are in inches and are approximate.
Contact Customer Service if dimensions are critical.

* Indicates model illustrated by line drawing.

Dialogue Conference Table Tops

Accent Panel with Metal Frame Surround and Access Lid(s)

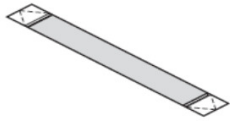

DESCRIPTION	MODEL	
Inlay: Frosted Mirror .25 thick frosted mirror with etched satin surface finish	DG 72XMAPL	inlay in 1 section
	DG 144XMAPL	inlay in 2 sections
	DG 240XMAPL	inlay in 3 sections
Inlay: Black Mirror .25 thick black mirror with etched satin surface finish	DG 72BMAPL	inlay in 1 section
	DG 144BMAPL	inlay in 2 sections
	DG 240BMAPL	inlay in 3 sections
Inlay: Black Glass .25 thick black glass with polished surface finish	DG 72TPAPL	inlay in 1 section
	DG 144TPAPL	inlay in 2 sections
	DG 240TPAPL	inlay in 3 sections
Inlay: White SSF .25 thick white acrylic with honed surface finish	DG 72SSFWAPL	inlay in 1 section
	DG 144SSFWAPL	inlay in 2 sections
	DG 240SSFWAPL	inlay in 3 sections
Inlay: Premium Veneer	DG 72VWAPL	inlay in 1 section
	DG 144VWAPL	inlay in 2 sections
	DG 240VWAPL	inlay in 3 sections
Inlay: Premium Veneer	Please contact Customer Service for premium veneer pricing	
Accent panels with access doors do not include power or data connections. Please contract customer service for power data options.		
NOTES		
FINISHES For a complete list of finishes please go to www.deccacontract.com	Dimensions are in inches and are approximate. Contact Customer Service if dimensions are critical.	
	* Indicates model illustrated by line drawing.	

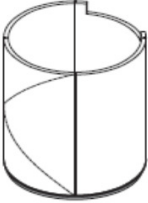
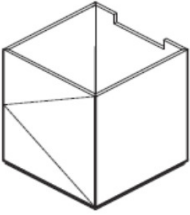
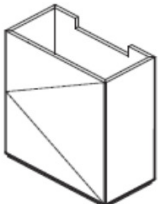

Dialogue Bases

DESCRIPTION	MODEL	Specifications		
		WIDTH	DEPTH	HEIGHT
Round Base with Access 	DG CY18MR	18	18	28.75
	DG CY20MR	20	20	28.75
	DG CY24MR	24	24	28.75
	DG CY30MR	30	30	28.75
	DG CY36MR	36	36	28.75
	DG CY48MR	48	48	28.75
Square Base with Access 	DG BX18MR	18	18	28.75
	DG BX20MR	20	20	28.75
	DG BX24MR	24	24	28.75
	DG BX30MR	30	30	28.75
	DG BX36MR	36	36	28.75
	DG BX48MR	48	48	28.75
Rectangular Base with Access 	DG PAT24MR	24	10	28.75
	DG PAT30MR	30	10	28.75
	DG PAT36MR	36	10	28.75
DIALOGUE BASES FEATURE - Recessed metal base with integral levelers - Vertical metal corner accents - Hinged panel for internal access - Open bottom to access floor outlets				
NOTES FINISHES For a complete list of finishes please go to www.deccacontract.com		Dimensions are in inches and are approximate. Contact Customer Service if dimensions are critical. * Indicates model illustrated by line drawing.		

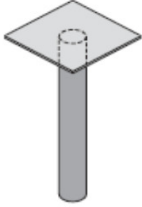
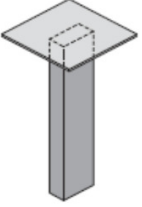
Dialogue Bases

DESCRIPTION	MODEL	Specifications		
		WIDTH	DEPTH	HEIGHT
<p>Round Metal Leg</p> 	DG ML	4	4	28.75
<p>Rectangular Metal Leg</p> 	DG WML	6	3	28.75
<p>- Integral levelers</p>				
<p>NOTES</p> <p>FINISHES For a complete list of finishes please go to www.deccacontract.com</p>		<p>Dimensions are in inches and are approximate. Contact Customer Service if dimensions are critical.</p> <p>* Indicates model illustrated by line drawing.</p>		

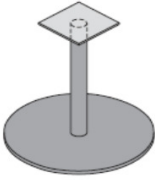
Dialogue Bases

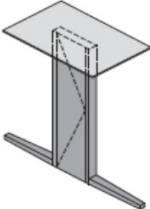
DESCRIPTION	MODEL	Specifications		
		WIDTH	DEPTH	HEIGHT
Disc Metal Base 	DG PT24	24	24	28.75
	DG PT30	30	30	28.75
	DG PT36	36	36	28.75
X Metal Base 	DG CM24	24	24	28.75
	DG CM30	30	30	28.75
	DG CM36	36	36	28.75
	DG CM3022	30	22	28.75
	DG CM3624	36	24	28.75
	DG CM4230	42	30	28.75
	DG CM4040	40	40	28.75
T Metal Base with access door 	DG T24M	24	4	28.75
	DG T30M	30	4	28.75
	DG T36M	36	4	28.75
DIALOGUE LEGS FEATURE - Welded steel construction with standard metal finish - Integral levelers				
NOTES FINISHES For a complete list of finishes please go to www.deccacontract.com		Dimensions are in inches and are approximate. Contact Customer Service if dimensions are critical. * Indicates model illustrated by line drawing.		

Dialogue Tall Table

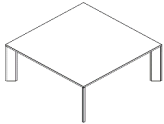
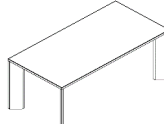
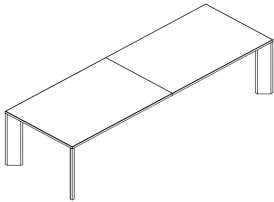
DESCRIPTION	MODEL	Specifications		
		WIDTH	DEPTH	HEIGHT
Tall Table - Square metal frame insert top 	DG MTD484836	48	48	36
	DG MTD545436	54	54	36
	DG MTD606036	60	60	36
	DG MTD727236	72	72	36
	DG MTD848436	84	84	36
Tall Table - Rectangular metal frame insert top 	DG MTD723636	72	36	36
	DG MTD844236	84	42	36
	DG MTD964236	96	42	36
Tall Table - Rectangular metal frame insert top two piece top 	DG MTD1204236	120	42	36
	DG MTD1204836	120	48	36
	DG MTD1444236	144	42	36
	DG MTD1444836	144	48	36
DIALOGUE TALL TABLE FEATURES - welded steel base with standard metal finish and wood finish top - Mitered case construction - Inset top surface options				
NOTES FINISHES For a complete list of finishes please go to www.deccacontract.com		Dimensions are in inches and are approximate. Contact Customer Service if dimensions are critical. * Indicates model illustrated by line drawing.		

Dialogue Metra Credenzas

DESCRIPTION	MODEL	Specifications		
		WIDTH	DEPTH	HEIGHT
<p>Metra Credenza</p> 	DG MFC601830	60	18	30
	DG MFC721830	72	18	30
	DG MFC841830	84	18	30
	DG MFC961830	96	18	30
	DG MFC1081830	108	18	30

- Left Section features hinged door
1 pull out tray and 1 drawer
- Center section with 1 adjustable shelf
- Right section features hinged door
1 pull out tray and 1 drawer

DIALOGUE METRA CREDENZA FEATURES

- welded steel base with standard metal finish and wood finish top
- Mitered case construction
- top surface options

NOTES

FINISHES

For a complete list of finishes please go to www.deccacontract.com

Dimensions are in inches and are approximate.
Contact Customer Service if dimensions are critical.

* Indicates model illustrated by line drawing.

Dialogue Credenzas

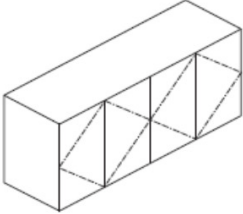
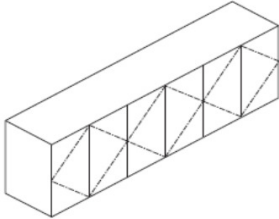
DESCRIPTION	MODEL	Specifications		
		WIDTH	DEPTH	HEIGHT
30" ht. Credenza . 4 doors and adjustable wood shelves 	DG NVC601830	60	18	30
	DG NVC721830	72	18	30
	DG NVC841830	84	18	30
30" ht. Credenza . 6 doors and adjustable wood shelves 	DG NVC901830	90	18	30
	DG NVC961830	96	18	30
DIALOGUE CREDENZA FEATURES - Recessed welded steel base with standard metal finish - Mitered case construction - Inset top surface options				
NOTES FINISHES For a complete list of finishes please go to www.deccacontract.com		Dimensions are in inches and are approximate. Contact Customer Service if dimensions are critical. * Indicates model illustrated by line drawing.		

Dialogue Credenzas

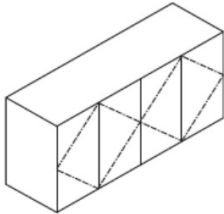
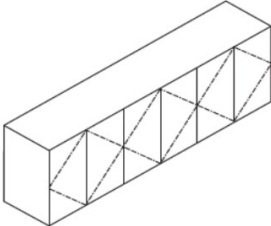
DESCRIPTION	MODEL	Specifications		
		WIDTH	DEPTH	HEIGHT
<p>36" ht. Service Credenza</p>  <ul style="list-style-type: none"> - Left Section features twin recycling containers on roll out frame - Center section with roll out wood trays - Right section features hinged door with space suitable for 1.6 cu.ft. refrigerator (not included) with venting provided through rear panels 	DG NVC602236S	60	22	36
	DG NVC722236S	72	22	36
	DG NVC842236S	84	22	36
<p>36" ht. Service Credenza</p>  <ul style="list-style-type: none"> - Left Section features twin recycling containers on roll out frame - Center section with roll out wood trays - Right section features hinged door with space suitable for 1.6 cu.ft. refrigerator (not included) with venting provided through rear panels <p>DIALOGUE CREDENZA FEATURES</p> <ul style="list-style-type: none"> - Recessed welded steel base with standard metal finish: select color per page 6. - Mitered case construction - Inset top surface options 	DG NVC902236S	90	22	36
	DG NVC962236S	96	22	36
NOTES				
<p>FINISHES</p> <p>For a complete list of finishes please go to www.deccacontract.com</p>		<p>Dimensions are in inches and are approximate. Contact Customer Service if dimensions are critical.</p> <p>* Indicates model illustrated by line drawing.</p>		

Dialogue Credenzas

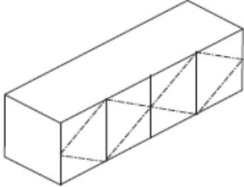
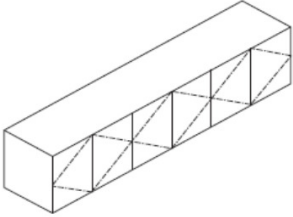
DESCRIPTION	MODEL	Specifications		
		WIDTH	DEPTH	HEIGHT
22" ht. Continental Credenza . 4 doors and adjustable wood shelves 	DG NVC601822	60	18	22
	DG NVC721822	72	18	22
	DG NVC841822	84	18	22
22" ht. Continental Credenza . 6 doors and adjustable wood shelves 	DG NVC901822	90	18	22
	DG NVC961822	96	18	22
DIALOGUE CREDENZA FEATURES - Recessed welded steel base with standard metal finish: select color per page 6. - Mitered case construction - Inset top surface options				
NOTES FINISHES For a complete list of finishes please go to www.deccacontract.com		Dimensions are in inches and are approximate. Contact Customer Service if dimensions are critical. * Indicates model illustrated by line drawing.		

Dialogue Idea Panel

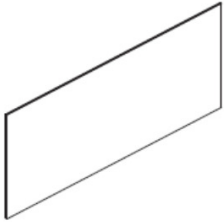
DESCRIPTION	MODEL	Specifications		
		WIDTH	HEIGHT	WEIGHT
<p>Idea Panel</p> 	DG VB7236T	72	36	160
	DG VB7836T	78	36	165
	DG VB8436T	84	36	170
	DG VB7248T	72	48	165
	DG VB7848T	78	48	170
	DG VB8448T	84	48	173

- Welded steel frame with standard metal finish: select color per page 6
- Integrated "z" clip wall attachment
- .25 inch thick back painted glass panel. Back painted glass is standard
- **Mounting of Idea Panel to the wall is the responsibility of the owner**

NOTES

FINISHES

For a complete list of finishes please go to www.deccacontract.com

Dimensions are in inches and are approximate. Contact Customer Service if dimensions are critical.

* Indicates model illustrated by line drawing.

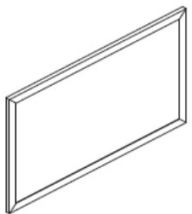
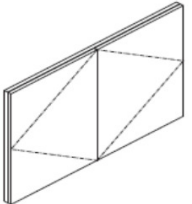

Wood Framed Visual Boards

DESCRIPTION	MODEL	Specifications		
		WIDTH	DEPTH	HEIGHT
<p>Wood Framed Visual Board Open</p> 	DG VB7236W	72	n/a	36
	DG VB7836W	78	n/a	36
	DG VB8436W	84	n/a	36
	DG VB7248W	72	n/a	48
	DG VB7848W	78	n/a	48
	DG VB8448W	84	n/a	48
	DG VB7254W	72	n/a	54
	DG VB7854W	78	n/a	54
<p>Wood Framed Visual Board Closed</p> 	DG VB4832	48	5.5	32
	DG VB4848	48	5.5	48
<p>WOOD FRAMED VISUAL BOARDS FEATURE</p> <ul style="list-style-type: none"> - Wood frame surround with mitered corners - Recessed non-marking dry-erase board - Integrated wood cleat system for wall attachment - Mounting of Visual Board to the wall is the responsibility of the owner. 				
<p>NOTES</p> <p>FINISHES</p> <p>For a complete list of finishes please go to www.deccacontract.com</p>		<p>Dimensions are in inches and are approximate. Contact Customer Service if dimensions are critical.</p> <p>* Indicates model illustrated by line drawing.</p>		

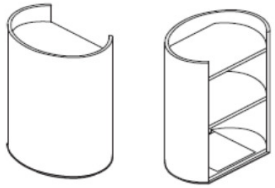
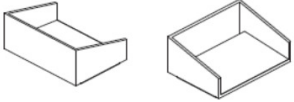
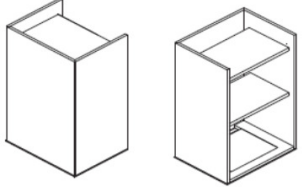
Lecterns and Podiums

DESCRIPTION	MODEL	Specifications		
		WIDTH	DEPTH	HEIGHT
<p>Oval Lectern</p> 	DG OTL2416	24.75	16.1	7.1
<p>Oval Podium</p> 	DG OPM271739	27	17	39
<p>Rectangular Lectern</p> 	DG RTL2215	22	15.5	7.1
<p>Rectangular Podium</p> 	DG RPM241839	24	18	39
<p>* Available on Podium only</p>				
<p>NOTES</p> <p>FINISHES</p> <p>For a complete list of finishes please go to www.deccacontract.com</p>		<p>Dimensions are in inches and are approximate. Contact Customer Service if dimensions are critical.</p> <p>* Indicates model illustrated by line drawing.</p>		

Mobile Carts

DESCRIPTION	MODEL	Specifications		
		WIDTH	DEPTH	HEIGHT
<p>Open</p> 	DG MC3621S	36	21	30
<p>Closed</p> 	DG MC3621SBC	36	21	30
<p>NOTES</p> <p>FINISHES For a complete list of finishes please go to www.deccacontract.com</p>		<p>Dimensions are in inches and are approximate. Contact Customer Service if dimensions are critical.</p> <p>* Indicates model illustrated by line drawing.</p>		

Basis Bases

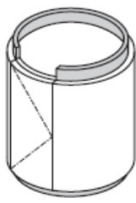
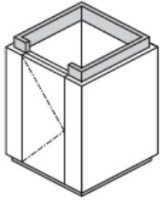
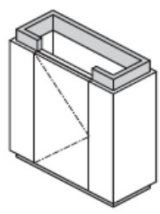
DESCRIPTION	MODEL	Specifications		
		WIDTH	DEPTH	HEIGHT
Round Base with Access 	BA CY18M	18	18	27.5
	BA CY20M	20	20	27.5
	BA CY24M	24	24	27.5
	BA CY30M	30	30	27.5
	BA CY36M	36	36	27.5
Square Base with Access 	BA BX18M	18	18	27.5
	BA BX20M	20	20	27.5
	BA BX24M	24	24	27.5
	BA BX30M	30	30	27.5
	BA BX36M	36	36	27.5
Rectangular Base with Access 	BA PAT24M	24	10	27.5
	BA PAT30M	30	10	27.5
	BA PAT34M	34	10	27.5
	BA PAT36M	36	10	27.5
NOTES				
FINISHES For a complete list of finishes please go to www.deccacontract.com		Dimensions are in inches and are approximate. Contact Customer Service if dimensions are critical.		
		* Indicates model illustrated by line drawing.		

Basis Bases

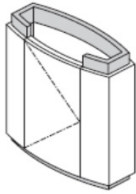
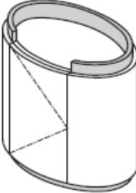
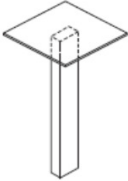
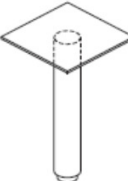
DESCRIPTION	MODEL	Specifications		
		WIDTH	DEPTH	HEIGHT
Bowed Rectangular Base with Access 	BA BR24M	24	10	27.5
	BA BR30M	30	10	27.5
	BA BR34M	34	10	27.5
	BA BR36M	36	10	27.5
Oval Base with Access 	BA EL24M	24	16	27.5
	BA EL30M	30	16	27.5
	BA EL34M	34	16	27.5
	BA EL36M	36	16	27.5
Rectangular Wood Leg 	BA WL	6	3	27.5
Round Wood Leg 	BA TL	3	3	27.5
NOTES FINISHES For a complete list of finishes please go to www.deccacontract.com		Dimensions are in inches and are approximate. Contact Customer Service if dimensions are critical. * Indicates model illustrated by line drawing.		

Basis Bases

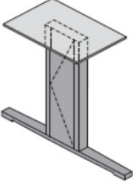
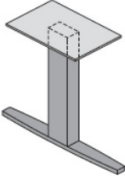
DESCRIPTION	MODEL	Specifications		
		WIDTH	DEPTH	HEIGHT
T Access Base Provides access to vertical chase for cables 	BA T24M	24	4	28.75
	BA T30M	30	4	28.75
	BA T36M	36	4	28.75
T Base 	BA T24	24	4	28.75
	BA T30	30	4	28.75
	BA T36	36	4	28.75
BASIS LEGS FEATURES - Welded steel construction with standard metal finish: select color per page 6. - Integral levelers				
NOTES FINISHES For a complete list of finishes please go to www.deccacontract.com Base includes adjustable glides along perimeter.		Dimensions are in inches and are approximate. Contact Customer Service if dimensions are critical. * Indicates model illustrated by line drawing.		

Basis Bases

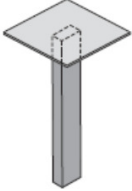
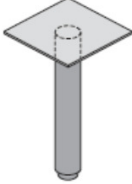
DESCRIPTION	MODEL	Specifications		
		WIDTH	DEPTH	HEIGHT
<p>Rectangular Metal Leg</p> 	BA WSL	6	3	28.75
<p>Round Metal Leg</p> 	BA TSL	3	3	28.75
<p>BASIS LEGS FEATURES</p> <ul style="list-style-type: none"> - Welded steel construction with standard metal finish: select color per page 6. - Integral levelers 				
<p>NOTES</p> <p>FINISHES</p> <p>For a complete list of finishes please go to www.deccacontract.com</p>		<p>Dimensions are in inches and are approximate. Contact Customer Service if dimensions are critical.</p> <p>* Indicates model illustrated by line drawing.</p>		

Basis Credenzas

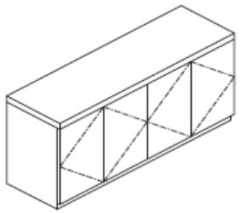
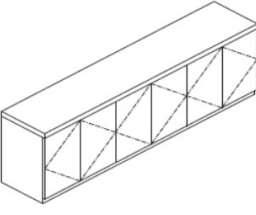
DESCRIPTION	MODEL	Specifications		
		WIDTH	DEPTH	HEIGHT
30" ht. Credenza . 4 doors and adjustable wood shelves 	DG BA601829	60	18	29
	DG BA721829	72	18	29
	DG BA841829	84	18	29
30" ht. Credenza . 6 doors and adjustable wood shelves 	DG BA901829	90	18	29
	DG BA961829	96	18	29
NOTES FINISHES For a complete list of finishes please go to www.deccacontract.com		Dimensions are in inches and are approximate. Contact Customer Service if dimensions are critical. * Indicates model illustrated by line drawing.		

Basis Credenzas

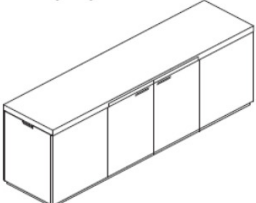
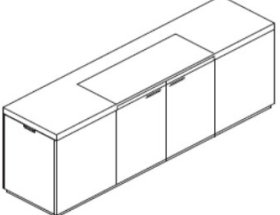
DESCRIPTION	MODEL	Specifications		
		WIDTH	DEPTH	HEIGHT
<p>34" ht. Service Credenza</p> <ul style="list-style-type: none"> - Center Doors - Top surface is standard Decca wood veneer with integrated cutlery trays 	DG BASC902234SW	90	22	34
<p>34" ht. Service Credenza</p> <ul style="list-style-type: none"> - Center Doors - Top surface Inset is Decca SSF solid surface in white with integrated cutlery trays  <ul style="list-style-type: none"> - Interior panels are Decca wood veneer - Exterior panels standard Decca wood veneer - Center section features paired hinged door, adjustable shelving within - Left Hand Side features pull out recycling containers - Right Hand Side features hinged door with space for 2.6 cu ft refrigerator (not included) with integrated venting through rear panels 	DG BASC902234SS	90	22	34
<p>NOTES</p> <p>FINISHES</p> <p>For a complete list of finishes please go to www.deccacontract.com</p>		<p>Dimensions are in inches and are approximate. Contact Customer Service if dimensions are critical.</p> <p>* Indicates model illustrated by line drawing.</p>		

Basis Credenzas

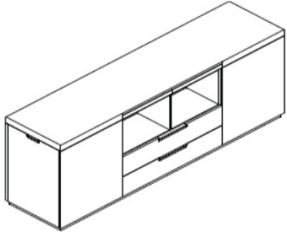
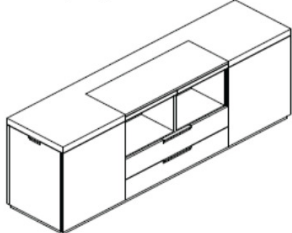
DESCRIPTION	MODEL	Specifications		
		WIDTH	DEPTH	HEIGHT
<p>34" ht. Service Credenza</p> <ul style="list-style-type: none"> - Center Drawers/Open Above - Top surface is standard Decca wood veneer with integrated cutlery trays 	BA SDC9022BCB	90	22	34
<p>34" ht. Service Credenza</p> <ul style="list-style-type: none"> - Center Drawers/Open Above - Top surface Inset is Decca SSF solid surface in white with integrated cutlery trays  <ul style="list-style-type: none"> - Interior panels are Decca wood veneer - Exterior panels standard Decca wood veneer - Center section features two open storage cubicles standard in Pearl White finish above, twin shallow storage drawers below - Left Hand Side features pull out recycling containers - Right Hand Side features hinged door with space for 2.6 cu ft refrigerator (not included) with integrated venting through rear panels 	BA SDC9022BCSB	90	22	34
<p>NOTES</p> <p>FINISHES</p> <p>For a complete list of finishes please go to www.deccacontract.com</p>		<p>Dimensions are in inches and are approximate. Contact Customer Service if dimensions are critical.</p> <p>* Indicates model illustrated by line drawing.</p>		

Basis Credenzas

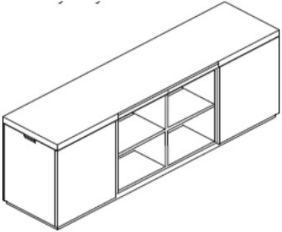
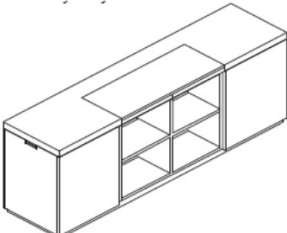
DESCRIPTION	MODEL	Specifications		
		WIDTH	DEPTH	HEIGHT
<p>34" ht. Service Credenza</p> <ul style="list-style-type: none"> - Center Open - Top surface is standard Decca wood veneer with integrated cutlery trays 	BA BSO9022BCB	90	22	34
<p>34" ht. Service Credenza</p> <ul style="list-style-type: none"> - Center Open - Top surface Inset is Decca SSF solid surface in white with integrated cutlery trays  <ul style="list-style-type: none"> - Interior panels are Decca wood veneer - Exterior panels standard Decca wood veneer - Center section features four open storage cubicles standard in Pearl White - Left Hand Side features pull out recycling containers - Right Hand Side features hinged door with space for 2.6 cu ft refrigerator (not included) with integrated venting through rear panels 	BA BSO9022BCSB	90	22	34
<p>NOTES</p> <p>FINISHES</p> <p>For a complete list of finishes please go to www.deccacontract.com</p>		<p>Dimensions are in inches and are approximate. Contact Customer Service if dimensions are critical.</p> <p>* Indicates model illustrated by line drawing.</p>		

Basis Media Wall

The **Basis Media Wall** provides an architectural presence to the modern conference room environment. The Media Wall is composed of three elements, a left hand, center and right hand cabinet, each offering a separate functional attribute. These cabinets are each offered in one standard configuration and finish and are not interchangeable.

Media Wall installation requires the attachment of units to wall via included wall cleats. Securing of units to the wall is the responsibility of the owner.

Mounting hardware for flat screen is not included.

Right Hand Cabinet

- 15" deep cabinet in painted finish
- One coat rod
- One fixed shelf above coat rod in painted finish
- Hinge door in painted finish (locks are optional on door fronts and must be specified at time of order)

DESCRIPTION	MODEL	Specifications		
		WIDTH	DEPTH	HEIGHT

Media Wall Curved

BA MWC12618

126 18 84

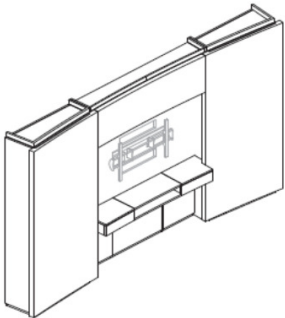

BA MWC14418

144 18 84

NOTES

FINISHES



For a complete list of finishes please go to www.deccacontract.com

Dimensions are in inches and are approximate. Contact Customer Service if dimensions are critical.

* Indicates model illustrated by line drawing.

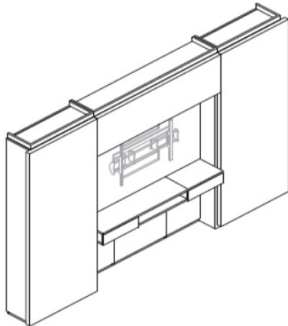
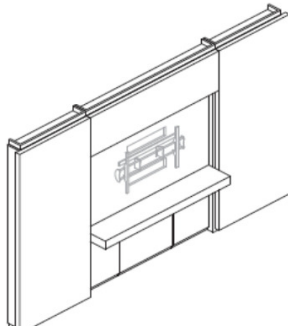
Basis Media Wall

DESCRIPTION	MODEL	Specifications		
		WIDTH	DEPTH	HEIGHT
Media Wall Straight 	BA MWS12618	126	18	84
	BA MWS14418	144	18	84
Media Wall Thin - Bottom Section includes fixed storage shelf only, no drawers are provided. 	BA MWT12612	126	12	84
	BA MWT14412	144	12	84
NOTES FINISHES For a complete list of finishes please go to www.deccacontract.com		Dimensions are in inches and are approximate. Contact Customer Service if dimensions are critical. * Indicates model illustrated by line drawing.		

Basis Media Wall		Specifications		
		WIDTH	DEPTH	HEIGHT
DESCRIPTION	MODEL			
<p>Open Storage Mobile Cart</p>  <ul style="list-style-type: none"> - Open Storage Cart has two levels of fixed height shelving - Welded steel frame construction with standard metal finish: select color per page 6. - Interior panels are standard in Pearl White - Exterior panels standard Decca wood veneer - Top Surface Decca SSF solid surface in white - Heavy duty casters in silver painted finish with 4" diameter black non-marring treads 	BA MC433034	43	30	34
<p>Closed Storage Mobile Cart</p>  <ul style="list-style-type: none"> - Open/Closed Storage Cart has one level of fixed height shelving and pull out storage drawer on each side. - Welded steel frame construction with standard metal finish: select color per page 6. - Interior panels are standard in Pearl White - Exterior panels standard Decca wood veneer - Top Surface Decca SSF solid surface in white - Heavy duty casters in silver painted finish with 4" diameter black non-marring treads 	BA MC433034F	43	30	34
<p>NOTES</p> <p>FINISHES For a complete list of finishes please go to www.deccacontract.com</p>		<p>Dimensions are in inches and are approximate. Contact Customer Service if dimensions are critical.</p> <p>* Indicates model illustrated by line drawing.</p>		

Index Bases

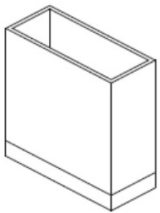
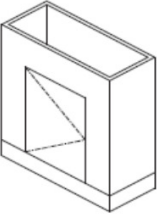
DESCRIPTION	MODEL	Specifications		
		WIDTH	DEPTH	HEIGHT
Rectangular Base 	DX PA24F	24	10	28.75
	DX PA30F	30	10	28.75
	DX PA36F	36	10	28.75
Rectangular Base with Access 	DX PA24FM	24	10	28.75
	DX PA30FM	30	10	28.75
	DX PA36FM	36	10	28.75
INDEX BASES FEATURE - Flush detail base with integral levelers - Hinged panel for internal access (optional) - Open bottom for floor access				
NOTES FINISHES For a complete list of finishes please go to www.deccacontract.com		Dimensions are in inches and are approximate. Contact Customer Service if dimensions are critical. * Indicates model illustrated by line drawing.		

Index Bases

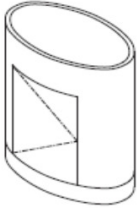
DESCRIPTION	MODEL	Specifications		
		WIDTH	DEPTH	HEIGHT
Oval Base 	DX BL24F	24	16	28.75
	DX BL30F	30	16	28.75
	DX BL36F	36	16	28.75
Oval Base with Access 	DX BL24FM	24	16	28.75
	DX BL30FM	30	16	28.75
	DX BL36FM	36	16	28.75
INDEX BASES FEATURE - Flush detail base with integral levelers - Hinged panel for internal access (optional) - Open bottom for floor access				
NOTES FINISHES For a complete list of finishes please go to www.deccacontract.com				
		Dimensions are in inches and are approximate. Contact Customer Service if dimensions are critical.		
		* Indicates model illustrated by line drawing.		

Index Bases

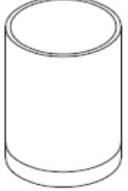
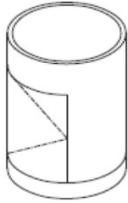
DESCRIPTION	MODEL	Specifications		
		WIDTH	DEPTH	HEIGHT
Round Base 	DX CY18F	18	18	28.75
	DX CY20F	20	20	28.75
	DX CY24F	24	24	28.75
	DX CY30F	30	30	28.75
	DX CY36F	36	36	28.75
	DX CY48F	48	48	28.75
Round Base with Access 	DX CY18FM	18	18	28.75
	DX CY20FM	20	20	28.75
	DX CY24FM	24	24	28.75
	DX CY30FM	30	30	28.75
	DX CY36FM	36	36	28.75
	DX CY48FM	48	48	28.75
INDEX BASES FEATURE - Flush detail base with integral levelers - Hinged panel for internal access (optional) - Open bottom for floor access				
NOTES FINISHES For a complete list of finishes please go to www.deccacontract.com		Dimensions are in inches and are approximate. Contact Customer Service if dimensions are critical. * Indicates model illustrated by line drawing.		

Index Bases

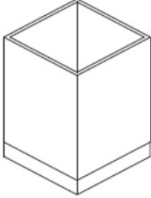
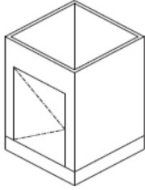
DESCRIPTION	MODEL	Specifications		
		WIDTH	DEPTH	HEIGHT
Square Base 	DX BX18F	18	18	28.75
	DX BX20F	20	20	28.75
	DX BX24F	24	24	28.75
	DX BX30F	30	30	28.75
	DX BX36F	36	36	28.75
	DX BX48F	48	48	28.75
Square Base with Access 	DX BX18FM	18	18	28.75
	DX BX20FM	20	20	28.75
	DX BX24FM	24	24	28.75
	DX BX30FM	30	30	28.75
	DX BX36FM	36	36	28.75
	DX BX48FM	48	48	28.75
INDEX BASES FEATURE - Flush detail base with integral levelers - Hinged panel for internal access (optional) - Open bottom for floor access				
NOTES FINISHES For a complete list of finishes please go to www.deccacontract.com				
		Dimensions are in inches and are approximate. Contact Customer Service if dimensions are critical.		
		* Indicates model illustrated by line drawing.		

Index Legs

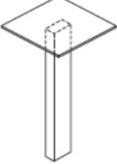
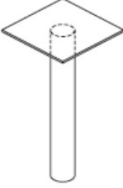
DESCRIPTION	MODEL	Specifications		
		WIDTH	DEPTH	HEIGHT
<p>Rectangular Wood</p> 	DX WL	2	4	28.75
<p>Round Wood</p> 	DX TL	4	4	28.75
<p>INDEX LEGS FEATURE - Integral levelers</p>				
<p>NOTES</p> <p>FINISHES For a complete list of finishes please go to www.deccacontract.com</p>		<p>Dimensions are in inches and are approximate. Contact Customer Service if dimensions are critical.</p> <p>* Indicates model illustrated by line drawing.</p>		

Index Legs

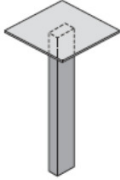
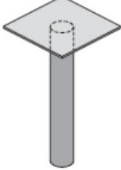
DESCRIPTION	MODEL	Specifications		
		WIDTH	DEPTH	HEIGHT
Rectangular Metal 	DX WSL	2	4	28.75
Round Metal 	DX TSL	4	4	28.75
INDEX LEGS FEATURE - Welded steel construction with standard metal finish - Integral levelers				
NOTES FINISHES For a complete list of finishes please go to www.deccacontract.com		Dimensions are in inches and are approximate. Contact Customer Service if dimensions are critical. * Indicates model illustrated by line drawing.		

Index Credenzas

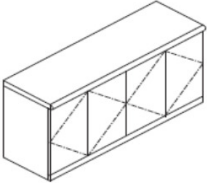
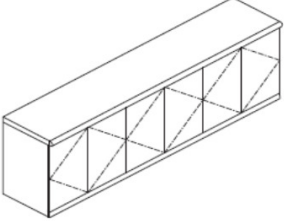
DESCRIPTION	MODEL	Specifications		
		WIDTH	DEPTH	HEIGHT
30" ht. Credenza . 4 doors and adjustable wood shelves 	DG DXC601830	60	18	30
	DG DXC721830	72	18	30
	DG DXC841830	84	18	30
30" ht. Credenza . 6 doors and adjustable wood shelves 	DG DXC901830	90	18	30
	DG DXC961830	96	18	30
NOTES FINISHES For a complete list of finishes please go to www.deccacontract.com		Dimensions are in inches and are approximate. Contact Customer Service if dimensions are critical. * Indicates model illustrated by line drawing.		

Index Credenzas

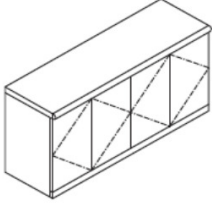
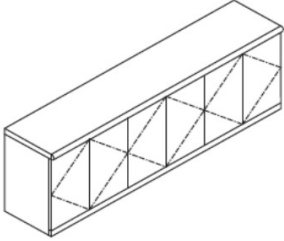
DESCRIPTION	MODEL	Specifications		
		WIDTH	DEPTH	HEIGHT
<p>36" ht. Service Credenza</p>  <ul style="list-style-type: none"> - Left Section features twin recycling containers on roll out frame - Right section features hinged door with space suitable for 1.6 cu.ft. refrigerator (not included) with venting provided through rear panels 	DG DXC602236S	60	22	36
	DG DXC722236S	72	22	36
	DG DXC842236S	84	22	36
<p>36" ht. Service Credenza</p>  <ul style="list-style-type: none"> - Left Section features twin recycling containers on roll out frame - Center section with roll out wood trays - Right section features hinged door with space suitable for 1.6 cu.ft. refrigerator (not included) with venting provided through rear panels 	DG DXSC902236S	90	22	36
	DG DXSC962236S	96	22	36
NOTES	<p>FINISHES</p> <p>For a complete list of finishes please go to www.deccacontract.com</p> <p style="text-align: right;">Dimensions are in inches and are approximate. Contact Customer Service if dimensions are critical.</p> <p style="text-align: right;">* Indicates model illustrated by line drawing.</p>			

Museum Wall Hung Credenzas

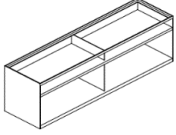
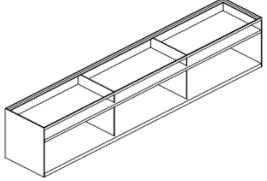
DESCRIPTION	MODEL	Specifications		
		WIDTH	DEPTH	HEIGHT
Museum Wall Hung Credenza open storage 	DG WOS601620	60	16	20
	DG WOS721620	72	16	20
	DG WOS901620	90	16	20
	DG WOS961620	96	16	20
<p>MUSEUM CREDENZA FEATURES</p> <ul style="list-style-type: none"> - Recessed welded steel base with standard metal finish. - Mitered case construction - Inset top surface options - Requires wall mounting by purchaser 				
<p>NOTES</p> <p>FINISHES For a complete list of finishes please go to www.deccacontract.com</p>				
		Dimensions are in inches and are approximate. Contact Customer Service if dimensions are critical.		
		* Indicates model illustrated by line drawing.		

Museum Wall Hung Credenzas

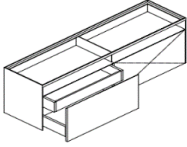
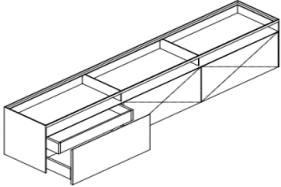
DESCRIPTION	MODEL	Specifications		
		WIDTH	DEPTH	HEIGHT
Museum Wall Hung Credenza with 4 drawers - 2 concealed 	DG WCR601620	60	16	20
	DG WCR721620	72	16	20
Museum Wall Hung Credenza with 6 drawers - 3 concealed 	DG WCR901620	90	16	20
	DG WCR961620	96	16	20
MUSEUM CREDENZA FEATURES - Recessed welded steel base with standard metal finish. - Mitered case construction - Inset top surface options - Requires wall mounting by purchaser				
NOTES FINISHES For a complete list of finishes please go to www.deccacontract.com		Dimensions are in inches and are approximate. Contact Customer Service if dimensions are critical. * Indicates model illustrated by line drawing.		

Museum Freestanding Credenzas

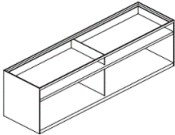
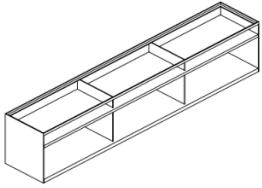
DESCRIPTION	MODEL	Specifications		
		WIDTH	DEPTH	HEIGHT
Museum Credenza open storage 	DG OS601822	60	18	21.5
	DG OS721822	72	18	22
	DG OS901822	90	18	22
	DG OS961822	96	18	22
MUSEUM CREDENZA FEATURES - Recessed welded steel base with standard metal finish. - Mitered case construction - Inset top surface options				
NOTES FINISHES For a complete list of finishes please go to www.deccacontract.com		Dimensions are in inches and are approximate. Contact Customer Service if dimensions are critical. * Indicates model illustrated by line drawing.		

Museum Freestanding Credenzas

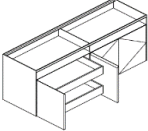
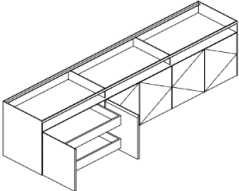
DESCRIPTION	MODEL	Specifications		
		WIDTH	DEPTH	HEIGHT
Museum Credenza with 4 concealed drawers 	DG BC601826	60	18	26
	DG BC721826	72	18	26
Museum Credenza with 6 concealed drawers 	DG BC901826	90	18	26
	DG BC961826	96	18	26
MUSEUM CREDENZA FEATURES - Recessed welded steel base with standard metal finish. - Mitered case construction - Inset top surface options				
NOTES FINISHES For a complete list of finishes please go to www.deccacontract.com		Dimensions are in inches and are approximate. Contact Customer Service if dimensions are critical. * Indicates model illustrated by line drawing.		

Museum Freestanding Credenzas

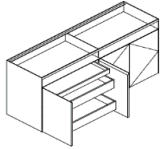
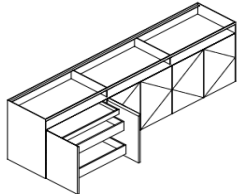
DESCRIPTION	MODEL	Specifications		
		WIDTH	DEPTH	HEIGHT
Museum Credenza with 6 concealed drawers 	DG BC601829	60	18	29
	DG BC721829	72	18	29
Museum Credenza with 9 concealed drawers 	DG BC901829	90	18	29
	DG BC961829	96	18	29
MUSEUM CREDENZA FEATURES - Recessed welded steel base with standard metal finish. - Mitered case construction - Inset top surface options				
NOTES FINISHES For a complete list of finishes please go to www.deccacontract.com		Dimensions are in inches and are approximate. Contact Customer Service if dimensions are critical. * Indicates model illustrated by line drawing.		

Museum Freestanding Credenzas

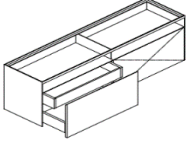
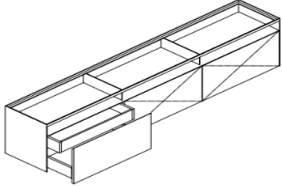
DESCRIPTION	MODEL	Specifications		
		WIDTH	DEPTH	HEIGHT
Museum Low Credenza with 4 drawers - 2 concealed 	DG LCR601822	60	18	22
	DG LCR721822	72	18	22
Museum Low Credenza with 6 drawers - 3 concealed 	DG LCR901822	90	18	22
	DG LCR961822	96	18	22
MUSEUM CREDENZA FEATURES - Recessed welded steel base with standard metal finish. - Mitered case construction - Inset top surface options				
NOTES FINISHES For a complete list of finishes please go to www.deccacontract.com		Dimensions are in inches and are approximate. Contact Customer Service if dimensions are critical. * Indicates model illustrated by line drawing.		

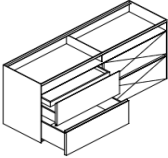
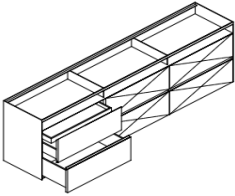

Museum Freestanding Credenzas

DESCRIPTION	MODEL	Specifications		
		WIDTH	DEPTH	HEIGHT
Museum Credenza with 6 drawers - 2 concealed 	DG CR601829	60	18	29
	DG CR721829	72	18	29
Museum Low Credenza with 9 drawers - 3 concealed 	DG CR901829	90	18	29
	DG CR961829	96	18	29
MUSEUM CREDENZA FEATURES - Recessed welded steel base with standard metal finish. - Mitered case construction - Inset top surface options				
NOTES FINISHES For a complete list of finishes please go to www.deccacontract.com		Dimensions are in inches and are approximate. Contact Customer Service if dimensions are critical. * Indicates model illustrated by line drawing.		

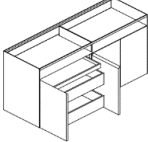
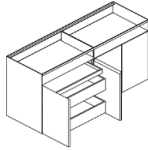
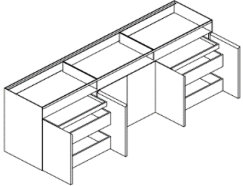
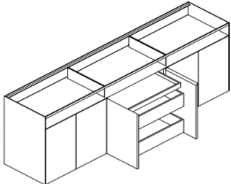
Museum Double Sided Credenzas

DESCRIPTION	MODEL	Specifications		
		WIDTH	DEPTH	HEIGHT
Museum Credenza double sided with 6 concealed drawers  	DG DBC602034	60	20	34
	DG DBC722034	72	20	34
Museum Credenza with 9 concealed drawers  	DG DBC902034	90	20	34
	DG DBC962034	96	20	34
<p>MUSEUM CREDENZA FEATURES</p> <ul style="list-style-type: none"> - Recessed welded steel base with standard metal finish. - Mitered case construction - Inset top surface options 				
<p>NOTES</p> <p>FINISHES For a complete list of finishes please go to www.deccacontract.com</p>				
		Dimensions are in inches and are approximate. Contact Customer Service if dimensions are critical.		
		* Indicates model illustrated by line drawing.		



Palladia Moderne Bases

DESCRIPTION	MODEL	Specifications		
		WIDTH	DEPTH	HEIGHT
Fluted Round Base 	PD CY18F	18	18	28.75
	PD CY20F	20	20	28.75
	PD CY24F	24	24	28.75
	PD CY30F	30	30	28.75
	PD CY36F	36	36	28.75
	PD CY48F	48	48	28.75
Fluted Round Base with Access 	PD CY18MF	18	18	28.75
	PD CY20MF	20	20	28.75
	PD CY24MF	24	24	28.75
	PD CY30MF	30	30	28.75
	PD CY36MF	36	36	28.75
	PD CY48MF	48	48	28.75
PALLADIA MODERNE BASES FEATURE - Signature Fluted Wood - Carved wood base with integral levelers - Hinged panel for internal access (optional) - Open bottom for floor access				
NOTES FINISHES For a complete list of finishes please go to www.deccacontract.com				
Dimensions are in inches and are approximate. Contact Customer Service if dimensions are critical. * Indicates model illustrated by line drawing.				

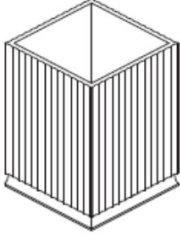
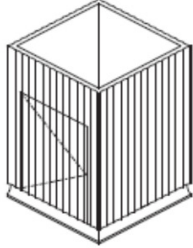
Palladia Moderne Bases

DESCRIPTION	MODEL	Specifications		
		WIDTH	DEPTH	HEIGHT
Fluted Square Base 	PD BX18F	18	18	28.75
	PD BX20F	20	20	28.75
	PD BX24F	24	24	28.75
	PD BX30F	30	30	28.75
	PD BX36F	36	36	28.75
	PD BX48F	48	48	28.75
Fluted Square Base with Access 	PD BX18MF	18	18	28.75
	PD BX20MF	20	20	28.75
	PD BX24MF	24	24	28.75
	PD BX30MF	30	30	28.75
	PD BX36MF	36	36	28.75
	PD BX48MF	48	48	28.75
PALLADIA MODERNE BASES FEATURE - Signature Fluted Wood - Carved wood base with integral levelers - Hinged panel for internal access (optional) - Open bottom for floor access				
NOTES FINISHES For a complete list of finishes please go to www.deccacontract.com		Dimensions are in inches and are approximate. Contact Customer Service if dimensions are critical. * Indicates model illustrated by line drawing.		

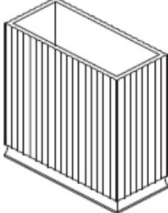
Palladia Moderne Bases

DESCRIPTION	MODEL	Specifications		
		WIDTH	DEPTH	HEIGHT
Fluted Rectangular Base 	PD PAT24F	24	10	28.75
	PD PAT30F	30	10	28.75
	PD PAT36F	36	10	28.75
Fluted Rectangular Base with Access 	PD PAT24MF	24	10	28.75
	PD PAT30MF	30	10	28.75
	PD PAT36MF	36	10	28.75
PALLADIA MODERNE BASES FEATURE - Signature Fluted Wood - Carved wood base with integral levelers - Hinged panel for internal access (optional) - Open bottom for floor access				
NOTES FINISHES For a complete list of finishes please go to www.deccacontract.com		Dimensions are in inches and are approximate. Contact Customer Service if dimensions are critical. * Indicates model illustrated by line drawing.		

Palladia Moderne Legs

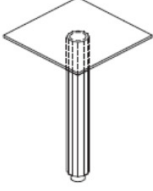
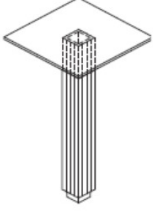
DESCRIPTION	MODEL	Specifications		
		WIDTH	DEPTH	HEIGHT
<p>Fluted Round Wood Leg</p> 	PD WF	4	4	28.75
<p>Fluted Square Wood Leg</p> 	PD RF	4	4	28.75
<p>PALLADIA MODERNE LEGS FEATURE - Signature Fluted Wood</p>				
<p>NOTES</p> <p>FINISHES For a complete list of finishes please go to www.deccacontract.com</p>				
		<p>Dimensions are in inches and are approximate. Contact Customer Service if dimensions are critical.</p> <p>* Indicates model illustrated by line drawing.</p>		

Palladia Moderne Credenzas

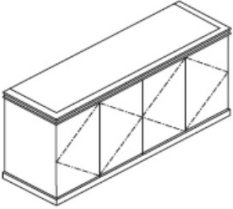
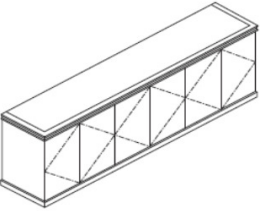
DESCRIPTION	MODEL	Specifications		
		WIDTH	DEPTH	HEIGHT
30" ht. Credenza . 4 doors and adjustable wood shelves 	DG PDC601830	60	18	30
	DG PDC721830	72	18	30
	DG PDC841830	84	18	30
30" ht. Credenza . 6 doors and adjustable wood shelves 	DG PDC901830	90	18	30
	DG PDC961830	96	18	30
NOTES FINISHES For a complete list of finishes please go to www.deccacontract.com		Dimensions are in inches and are approximate. Contact Customer Service if dimensions are critical. * Indicates model illustrated by line drawing.		

Palladia Moderne Credenzas

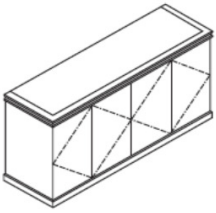
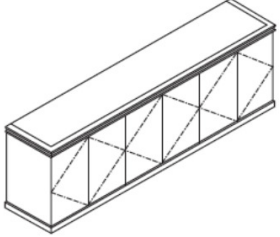
DESCRIPTION	MODEL	Specifications		
		WIDTH	DEPTH	HEIGHT
36" ht. Service Credenza  <ul style="list-style-type: none"> - Left Section features twin recycling containers on roll out frame - Right section features hinged door with space suitable for 1.6 cu.ft. refrigerator (not included) with venting provided through rear panels 	DG PDC602236S	60	22	36
	DG PDC722236S	72	22	36
	DG PDC842236S	84	22	36
36" ht. Service Credenza  <ul style="list-style-type: none"> - Left Section features twin recycling containers on roll out frame - Center section with roll out wood trays - Right section features hinged door with space suitable for 1.6 cu.ft. refrigerator (not included) with venting provided through rear panels 	DG PDC902236S	90	22	36
	DG PDC962236S	96	22	36
NOTES FINISHES For a complete list of finishes please go to www.deccacontract.com	Dimensions are in inches and are approximate. Contact Customer Service if dimensions are critical. * Indicates model illustrated by line drawing.			

Palladia Classic Bases

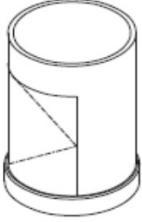
DESCRIPTION	MODEL	Specifications		
		WIDTH	DEPTH	HEIGHT
Round Base 	PC CY18	18	18	28.75
	PC CY20	20	20	28.75
	PC CY24	24	24	28.75
	PC CY30	30	30	28.75
	PC CY36	36	36	28.75
	PC CY48	48	48	28.75
Round Base with Access 	PC CY18M	18	18	28.75
	PC CY20M	20	20	28.75
	PC CY24M	24	24	28.75
	PC CY30M	30	30	28.75
	PC CY36M	36	36	28.75
	PC CY48M	48	48	28.75
PALLADIA CLASSIC BASES FEATURE - Carved wood base with integral levelers - Hinged panel for internal access (optional) - Open bottom for floor access				
NOTES FINISHES For a complete list of finishes please go to www.deccacontract.com				
		Dimensions are in inches and are approximate. Contact Customer Service if dimensions are critical.		
		* Indicates model illustrated by line drawing.		

Palladia Classic Bases

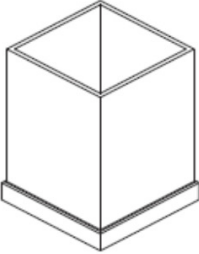
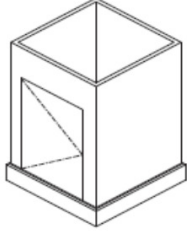
DESCRIPTION	MODEL	Specifications		
		WIDTH	DEPTH	HEIGHT
Square Base 	PC BX18	18	18	28.75
	PC BX20	20	20	28.75
	PC BX24	24	24	28.75
	PC BX30	30	30	28.75
	PC BX36	36	36	28.75
	PC BX48	48	48	28.75
Square Base with Access 	PC BX18M	18	18	28.75
	PC BX20M	20	20	28.75
	PC BX24M	24	24	28.75
	PC BX30M	30	30	28.75
	PC BX36M	36	36	28.75
	PC BX48M	48	48	28.75
<p>PALLADIA CLASSIC BASES FEATURE</p> <ul style="list-style-type: none"> - Carved wood base with integral levelers - Hinged panel for internal access (optional) - Open bottom for floor access 				
<p>NOTES</p> <p>FINISHES</p> <p>For a complete list of finishes please go to www.deccacontract.com</p>		<p>Dimensions are in inches and are approximate. Contact Customer Service if dimensions are critical.</p> <p>* Indicates model illustrated by line drawing.</p>		

Palladia Classic Bases

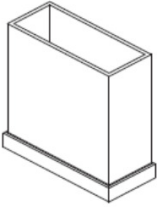
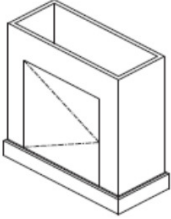
DESCRIPTION	MODEL	Specifications		
		WIDTH	DEPTH	HEIGHT
Rectangular Base 	PC PAT24	24	10	28.75
	PC PAT30	30	10	28.75
	PC PAT36	36	10	28.75
Rectangular Base with Access 	PC PAT24M	24	10	28.75
	PC PAT30M	30	10	28.75
	PC PAT36M	36	10	28.75
PALLADIA CLASSIC BASES FEATURE - Carved wood base with integral levelers - Hinged panel for internal access (optional) - Open bottom for floor access				
NOTES FINISHES For a complete list of finishes please go to www.deccacontract.com		Dimensions are in inches and are approximate. Contact Customer Service if dimensions are critical. * Indicates model illustrated by line drawing.		

Palladia Classic Bases

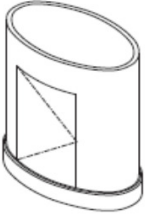
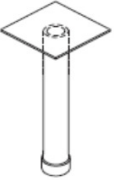
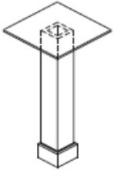

DESCRIPTION	MODEL	Specifications		
		WIDTH	DEPTH	HEIGHT
Oval Base 	PC BL24	24	10	28.75
	PC BL30	30	10	28.75
	PC BL36	36	10	28.75
Oval Base with Access 	PC BL24M	24	10	28.75
	PC BL30M	30	10	28.75
	PC BL36M	36	10	28.75
Round Wood Leg 	PC W	4	4	28.75
Square Wood Leg 	PC R	4	4	28.75
NOTES FINISHES For a complete list of finishes please go to www.deccacontract.com		Dimensions are in inches and are approximate. Contact Customer Service if dimensions are critical. * Indicates model illustrated by line drawing.		

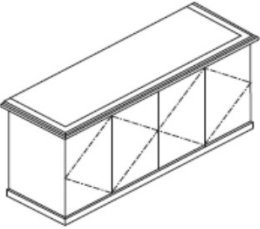
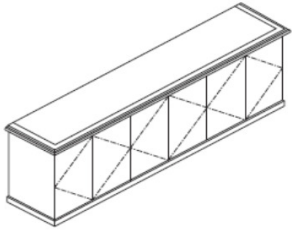
Palladia Classic Credenzas

DESCRIPTION	MODEL	Specifications		
		WIDTH	DEPTH	HEIGHT
30" ht. Credenza . 4 doors and adjustable wood shelves 	DG PCC601830	60	18	30
	DG PCC721830	72	18	30
	DG PCC841830	84	18	30
30" ht. Credenza . 6 doors and adjustable wood shelves 	DG PCC901830	90	18	30
	DG PCC961830	96	18	30
NOTES FINISHES For a complete list of finishes please go to www.deccacontract.com	Dimensions are in inches and are approximate. Contact Customer Service if dimensions are critical. * Indicates model illustrated by line drawing.			

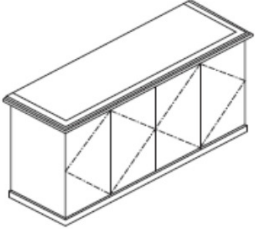
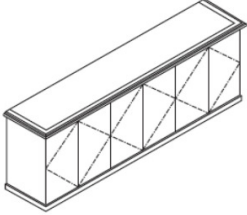
Palladia Classic Credenzas

DESCRIPTION	MODEL	Specifications		
		WIDTH	DEPTH	HEIGHT
36" ht. Service Credenza  <ul style="list-style-type: none"> - Left Section features twin recycling containers on roll out frame - Right section features hinged door with space suitable for 1.6 cu.ft. refrigerator (not included) with venting provided through rear panels 	DG PCC602236S	60	22	36
	DG PCC722236S	72	22	36
	DG PCC842236S	84	22	36
36" ht. Service Credenza  <ul style="list-style-type: none"> - Left Section features twin recycling containers on roll out frame - Center section with roll out wood trays - Right section features hinged door with space suitable for 1.6 cu.ft. refrigerator (not included) with venting provided through rear panels 	DG PCC902236S	90	22	36
	DG PCC962236S	96	22	36
NOTES				
FINISHES For a complete list of finishes please go to www.deccacontract.com		Dimensions are in inches and are approximate. Contact Customer Service if dimensions are critical.		
		* Indicates model illustrated by line drawing.		

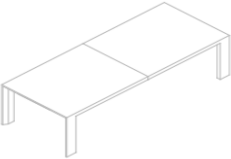
Ratio		Specifications		
		WIDTH	DEPTH	HEIGHT
DESCRIPTION	MODEL			
Ratio - Square 29" high two drawers opposite sides 	DG TD484829	48	48	29
	DG TD545429	54	54	29
	DG TD606029	60	60	29
	DG TD727229	72	72	29
	DG TD848429	84	84	29
Ratio - Rectangular 29" high drawer on each end 	DG TD723629	72	36	29
	DG TD844229	84	42	29
	DG TD964229	96	42	29
	DG TD964829	96	48	29
Ratio - Rectangular 29" high two piece top drawer on each end 	DG TD120429	120	42	29
	DG TD1204829	120	48	29
	DG TD144429	144	42	29
	DG TD1444829	144	48	29
	DG TD1564829	156	48	29
	DG TD1565429	156	54	29
	DG TD1684829	168	48	29
	DG TD1685429	168	54	29
NOTES				
FINISHES For a complete list of finishes please go to www.deccacontract.com				Dimensions are in inches and are approximate. Contact Customer Service if dimensions are critical. * Indicates model illustrated by line drawing.

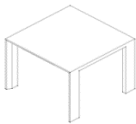
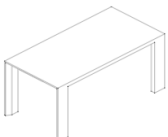
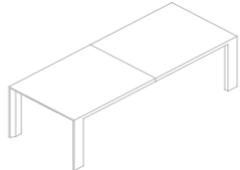
Ratio		Specifications		
		WIDTH	DEPTH	HEIGHT
DESCRIPTION	MODEL			
Ratio - Square 36" high two drawers opposite sides 	DG TD484836	48	48	36
	DG TD545436	54	54	36
	DG TD606036	60	60	36
	DG TD727236	72	72	36
	DG TD848436	84	84	36
Ratio - Rectangular 36" high drawer on each end 	DG TD723636	72	36	36
	DG TD844236	84	42	36
	DG TD964236	96	42	36
	DG TD964836	96	48	36
Ratio - Rectangular 36" high drawer on each end two piece top 	DG TD1204236	120	42	36
	DG TD1204836	120	48	36
	DG TD1444236	144	42	36
	DG TD1444836	144	48	36
NOTES				
FINISHES For a complete list of finishes please go to www.deccacontract.com		Dimensions are in inches and are approximate. Contact Customer Service if dimensions are critical.		
		* Indicates model illustrated by line drawing.		

Turnberry Bases

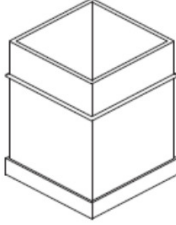
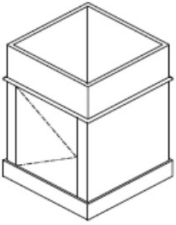
DESCRIPTION	MODEL	Specifications		
		WIDTH	DEPTH	HEIGHT
Square Base 	TB BX18	18	18	28.75
	TB BX20	20	20	28.75
	TB BX24	24	24	28.75
	TB BX30	30	30	28.75
	TB BX36	36	36	28.75
Square Base with Access 	TB BX18M	18	18	28.75
	TB BX20M	20	20	28.75
	TB BX24M	24	24	28.75
	TB BX30M	30	30	28.75
	TB BX36M	36	36	28.75
TURNBERRY BASES FEATURE - Carved wood base with integral levelers - Horizontal wood moulding detail - Hinged panel for internal access (optional) - Open bottom for floor access				
NOTES FINISHES For a complete list of finishes please go to www.deccacontract.com		Dimensions are in inches and are approximate. Contact Customer Service if dimensions are critical. * Indicates model illustrated by line drawing.		

Turnberry Bases

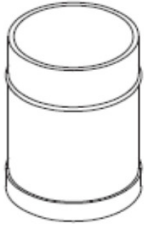
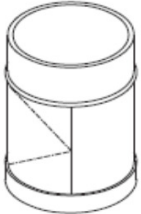
DESCRIPTION	MODEL	Specifications		
		WIDTH	DEPTH	HEIGHT
Round Base 	TB CY18	18	18	28.75
	TB CY20	20	20	28.75
	TB CY24	24	24	28.75
	TB CY30	30	30	28.75
	TB CY36	36	36	28.75
Round Base with Access 	TB CY18M	18	18	28.75
	TB CY20M	20	20	28.75
	TB CY24M	24	24	28.75
	TB CY30M	30	30	28.75
	TB CY36M	36	36	28.75
TURNBERRY BASES FEATURE - Carved wood base with integral levelers - Horizontal wood moulding detail - Hinged panel for internal access (optional) - Open bottom for floor access				
NOTES FINISHES For a complete list of finishes please go to www.deccacontract.com		Dimensions are in inches and are approximate. Contact Customer Service if dimensions are critical. * Indicates model illustrated by line drawing.		

Turnberry Bases

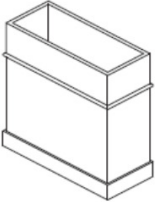
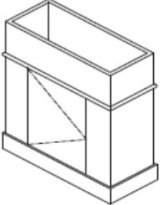
DESCRIPTION	MODEL	Specifications		
		WIDTH	DEPTH	HEIGHT
Rectangular Base 	TB PAT24	24	10	28.75
	TB PAT30	30	10	28.75
	TB PAT36	36	10	28.75
Rectangular Base with Access 	TB PAT24M	24	10	28.75
	TB PAT30M	30	10	28.75
	TB PAT36M	36	10	28.75
TURNBERRY BASES FEATURE - Carved wood base with integral levelers - Horizontal wood moulding detail - Hinged panel for internal access (optional) - Open bottom for floor access				
NOTES FINISHES For a complete list of finishes please go to www.deccacontract.com		Dimensions are in inches and are approximate. Contact Customer Service if dimensions are critical. * Indicates model illustrated by line drawing.		

Turnberry Bases

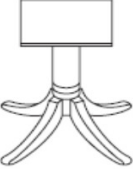
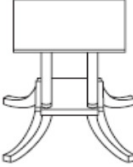
DESCRIPTION	MODEL	Specifications		
		WIDTH	DEPTH	HEIGHT
4 Prong Base 	TB PR24	24	24	28.75
	TB PR30	30	30	28.75
	TB PR36	36	36	28.75
Pedestal 	TB PE16	16	16	28.75
	TB PE24	24	24	28.75
	TB PE30	30	30	28.75

NOTES

FINISHES
 For a complete list of finishes
 please go to www.deccacontract.com

Dimensions are in inches and are approximate.
 Contact Customer Service if dimensions are critical.

* Indicates model illustrated by line drawing.

Turnberry Credenzas

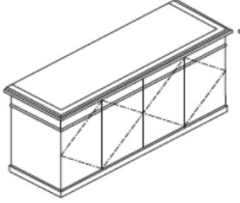
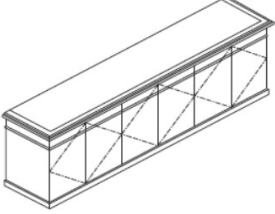
DESCRIPTION	MODEL	Specifications		
		WIDTH	DEPTH	HEIGHT
30" ht. Credenza . 4 doors and adjustable wood shelves 	DG TBC601830	60	18	30
	DG TBC721830	72	18	30
	DG TBC841830	84	18	30
30" ht. Credenza . 6 doors and adjustable wood shelves 	DG TBC901830	90	18	30
	DG TBC961830	96	18	30
NOTES FINISHES For a complete list of finishes please go to www.deccacontract.com	Dimensions are in inches and are approximate. Contact Customer Service if dimensions are critical. * Indicates model illustrated by line drawing.			

Turnberry Credenzas

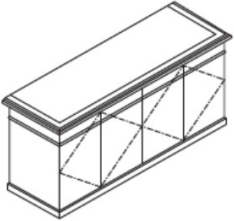
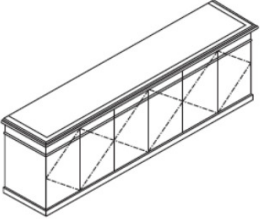
DESCRIPTION	MODEL	Specifications		
		WIDTH	DEPTH	HEIGHT
36" ht. Service Credenza with 4 doors  <ul style="list-style-type: none"> - Left Section features twin recycling containers on roll out frame - Right section features hinged door with space suitable for 1.6 cu.ft. refrigerator (not included) with venting provided through rear panels 	DG TBC602436S	60	24	36
	DG TBC722436S	72	24	36
	DG TBC842436S	84	24	36
36" ht. Service Credenza  <ul style="list-style-type: none"> - Left Section features twin recycling containers on roll out frame - Center section with roll out wood trays - Right section features hinged door with space suitable for 1.6 cu.ft. refrigerator (not included) with venting provided through rear panels 	DG TBC902436S	90	24	36
	DG TBC962436S	96	24	36
NOTES				
FINISHES For a complete list of finishes please go to www.deccacontract.com		Dimensions are in inches and are approximate. Contact Customer Service if dimensions are critical.		
		* Indicates model illustrated by line drawing.		